

SC075N120Y

33 Amps, 1200 Volts N-Channel Sic Power MOSFET

Features

- 33A, 1200V, $R_{DS(ON)MAX}=95m\ \Omega$ @ $V_{GS}=18V/20A$
- High Blocking Voltage with low On-Resistance
- High Speed Switching with Low Capacitance
- Easy to Parallel and Simple to Drive

Benefits

- Higher System Efficiency
- Reduced Cooling Requirements
- Increased Power Density
- Increased System Switching Frequencytance

Applications

- Renewable Energy
- EV Battery Chargers
- High Voltage DC/DC Converters
- Switch Mode Power Supplies

TO-247-3L

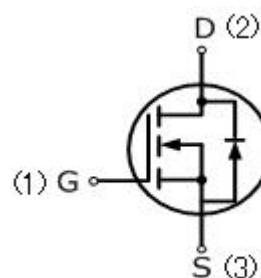
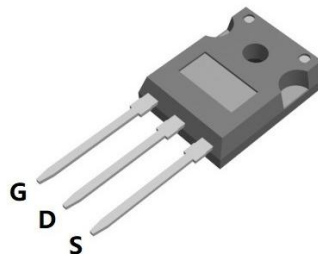

Absolute Maximum Ratings ($T_c=25^\circ\text{C}$, unless otherwise noted)

Parameter	Symbol	Value	UNIT	Test Conditions
Drain-Source Voltage	V_{DSmax}	1200	V	$V_{GS}=0V, I_{DS}=100\mu A$
Gate-Source Voltage (dynamic)	V_{GSmax}	-8/+22		Absolute maximum values
Gate-Source Voltage (static)	V_{GSop}	-4/+18		Recommended operational values
Continuous Drain Current	I_D	33	A	$V_{GS}=18V, T_c=25^\circ\text{C}$
		23.8		$V_{GS}=18V, T_c=100^\circ\text{C}$
Pulsed Drain Current	$I_{D(pulse)}$	80	A	Pulse width t_p limited by T_{Jmax}
Power Dissipation	P_D	136	W	$T_c=25^\circ\text{C}, T_J=150^\circ\text{C}$
Operating Junction and Storage Temperature Range	T_J, T_{STG}	-55 to +175	$^\circ\text{C}$	

Thermal Characteristics

Parameter	Symbol	SC075N120Y	Units
Maximum Junction-to-Case	R_{thJC}	0.84	$^\circ\text{C}/\text{W}$

Electrical Characteristics ($T_c=25^\circ\text{C}$, unless otherwise noted)						
Parameter	Symbol	Test Conditions	Min	Typ	Max	Units
Drain-Source Breakdown Voltage	BV_{DSS}	$V_{GS}=0V, I_D=100\mu A$	1200	—	—	V
Zero Gate Voltage Drain Current	I_{DSS}	$V_{DS}=1200V, V_{GS}=0V$	—	1	100	μA
Gate-Body Leakage Current, Forward	I_{GSSF}	$V_{GS}=22V, V_{DS}=0V$	—	10	250	nA
Gate-Body Leakage Current, Reverse	I_{GSSR}	$V_{GS}=-8V, V_{DS}=0V$	—	10	250	nA
Gate-Source Threshold Voltage	$V_{GS(th)}$	$V_{DS}=V_{GS}, I_D=5mA$	1.9	2.6	4.0	V
Drain-Source On-State Resistance	$R_{DS(on)}$	$V_{GS}=18V, I_D=20A$	—	75	95	m Ω
		$V_{GS}=18V, I_D=20A, T_J=175^\circ\text{C}$	—	120	—	
Input Capacitance	C_{iss}	$V_{DS}=1000V,$	—	1200	—	pF
Output Capacitance	C_{oss}	$V_{GS}=0V,$	—	63	—	pF
Reverse Transfer Capacitance	C_{rss}	$f=1.0\text{MHz},$	—	9.8	—	pF
Coss Stored Energy	E_{OSS}	$V_{AC}=25mV$	—	41	—	μJ
Turn-On Delay Time	$t_{d(on)}$	$V_{DS}=800V, V_{GS}=-4V/18V,$ $I_D=20A, R_g=2.5\Omega, R_L=20\Omega$	—	13	—	ns
Turn-On Rise Time	t_r		—	12	—	ns
Turn-Off Delay Time	$t_{d(off)}$		—	16	—	ns
Turn-Off Fall Time	t_f		—	10	—	ns
Turn-On Switching Energy	E_{ON}	$V_{DS}=800V, V_{GS}=-4V/18V$	—	586	—	μJ
Turn-Off Switching Energy	E_{OFF}	$I_D=20A, R_g=2.5\Omega, L=100\mu H$	—	273	—	μJ
Internal Gate Resistance	R_G	$f=1\text{MHz}, V_{AC}=25mV$	—	5.5	—	Ω
Total Gate Charge	Q_g	$V_{DS}=800V, I_D=20A,$ $V_{GS}=-4V/18V$	—	68.1	—	nC
Gate-Source Charge	Q_{GS}		—	21.5	—	
Gate-Drain Charge	Q_{gd}		—	14.6	—	
Reverse Diode Characteristics						
Diode Forward Voltage	V_{SD}	$V_{GS}=-4V, I_{SD}=10A$	—	4.2	—	V
		$V_{GS}=-4V, I_{SD}=10A, T_J=175^\circ\text{C}$	—	3.8	—	
Continuous Diode Forward Current	I_S	$T_C=25^\circ\text{C}$	—	—	33	A
Reverse Recover Time	t_{rr}	$V_R=800V, I_{SD}=20A$	—	28	—	ns
Reverse Recovery Charge	Q_{rr}		—	62	—	nc
Peak Reverse Recovery Current	I_{rrm}		—	3.7	—	A

RATING AND CHARACTERISTIC CURVES

Figure.1 Output Characteristics $T_j=25^\circ\text{C}$

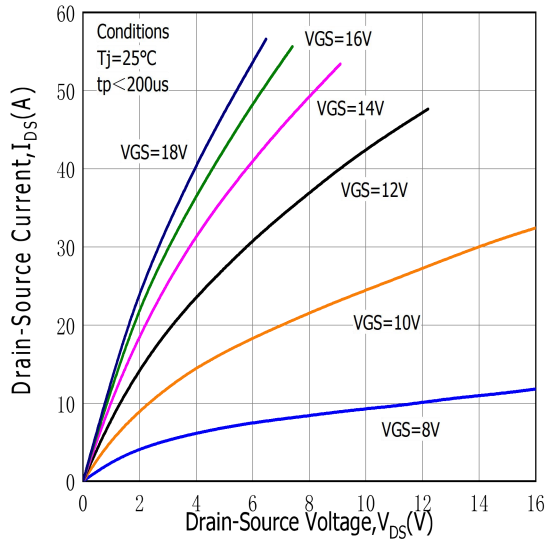

Figure.2 Output Characteristics $T_j=175^\circ\text{C}$

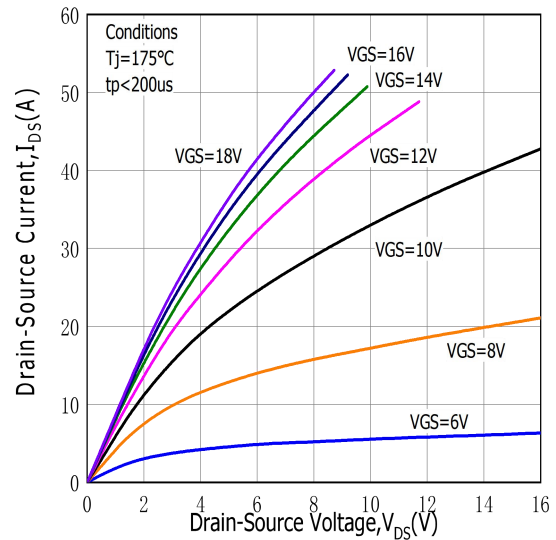

Figure.3 On-Resistance vs. Temperature

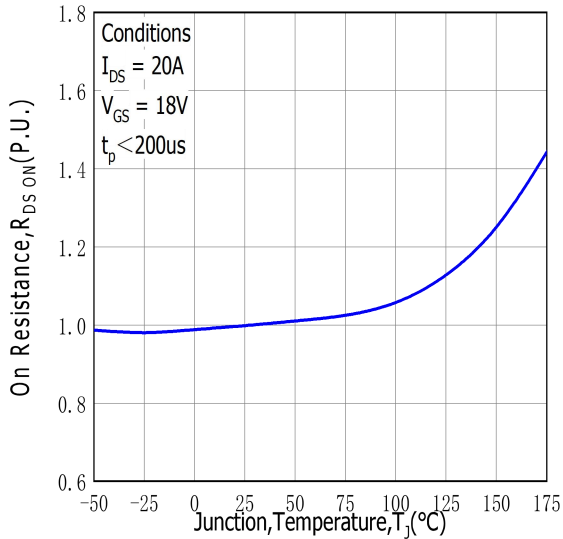

Figure.4 On-Resistance vs. Drain Current for Various Temperatures

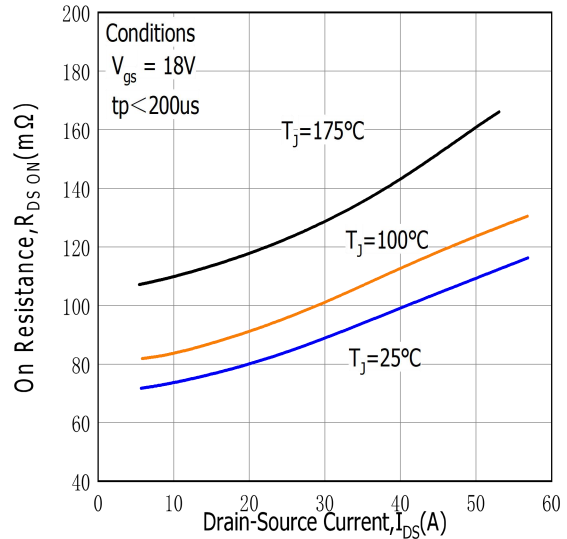

Figure.5 On-Resistance vs. Temperature for Various Gate Voltage

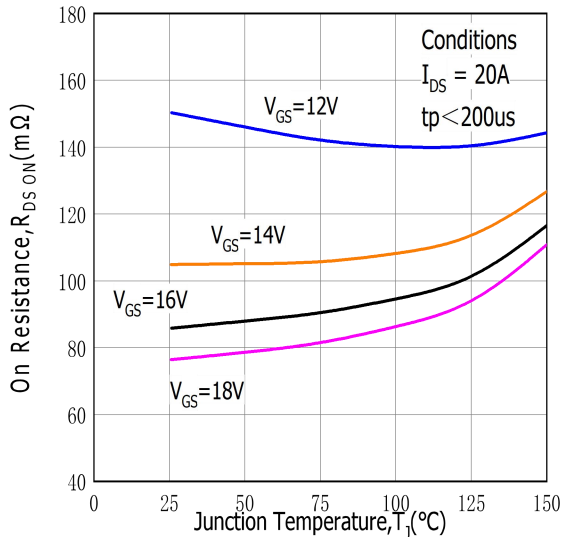

Figure.6 Transfer Characteristic for Various Junction Temperatures

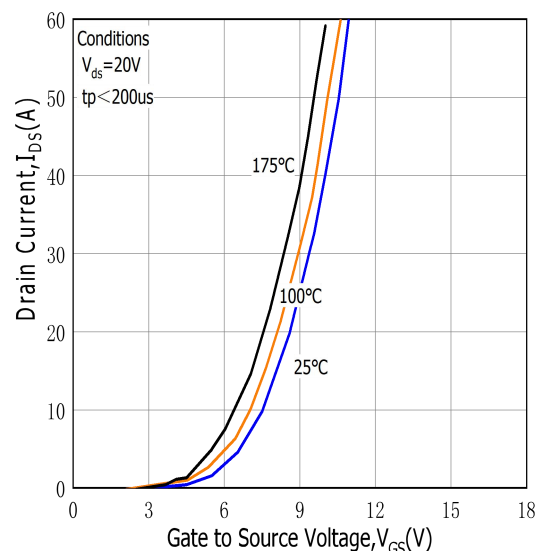

Figure.7 Body Diode Characteristic at 25°C

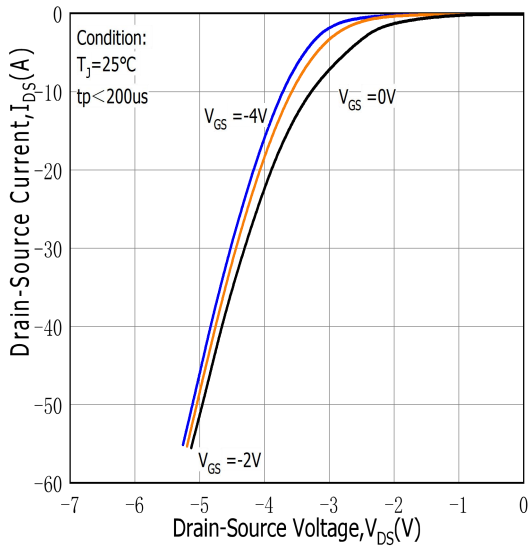

Figure.8 Body Diode Characteristic at 175°C

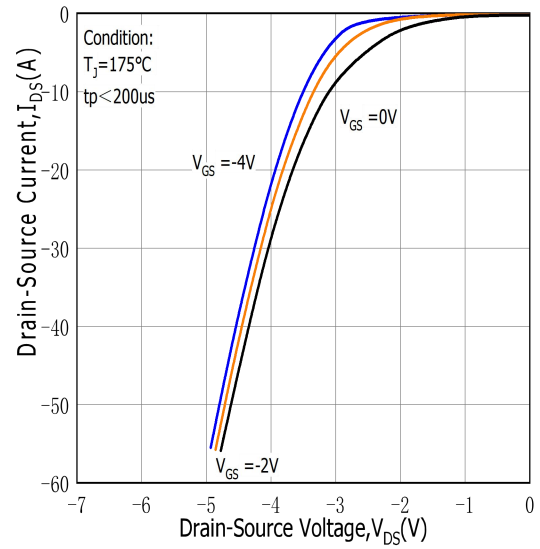

Figure.9 Threshold Voltage vs. Temperature

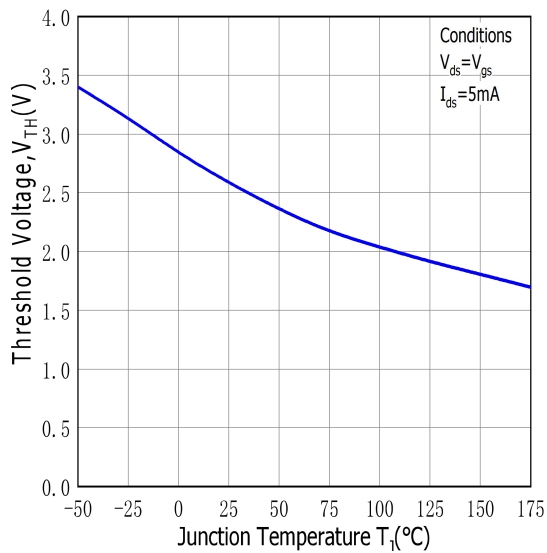

Figure.10 Gate Charge Characteristics

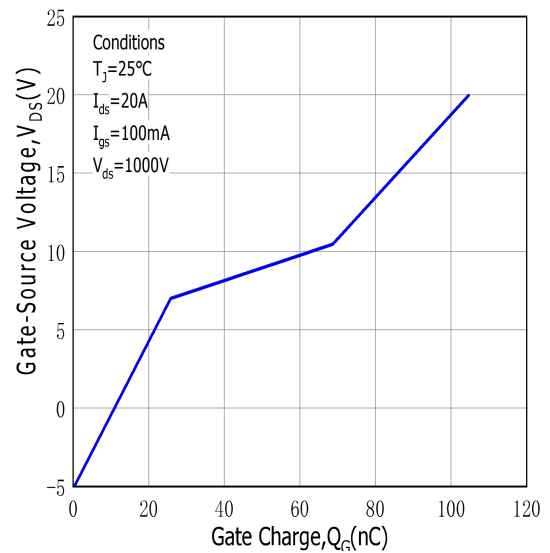

Figure.11 3rd Quadrant Characteristic at 25°C

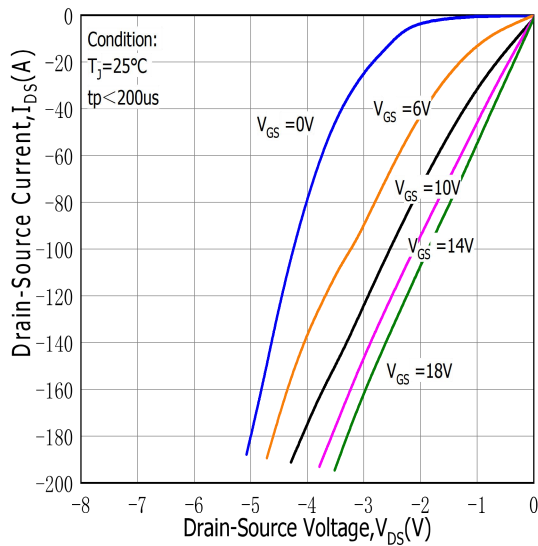

Figure.12 3rd Quadrant Characteristic at 175°C

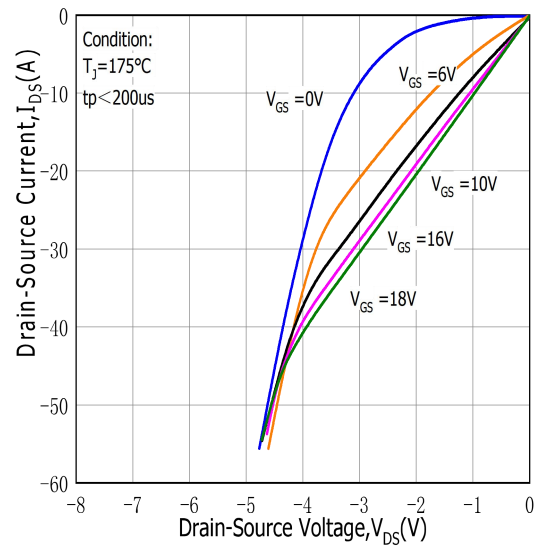

Figure.13 Capacitances vs. Drain-Source Voltage(0-200V)

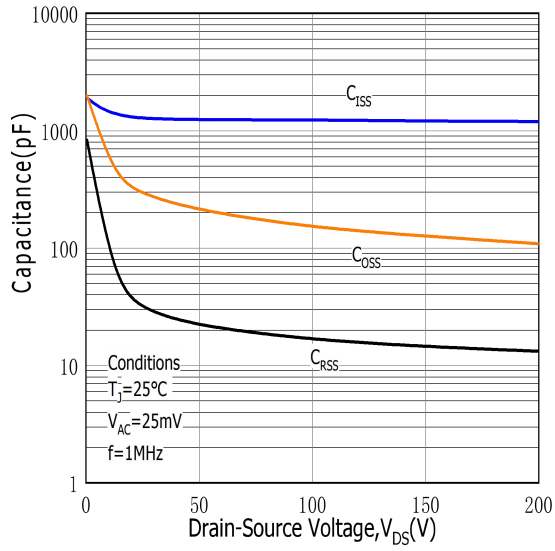
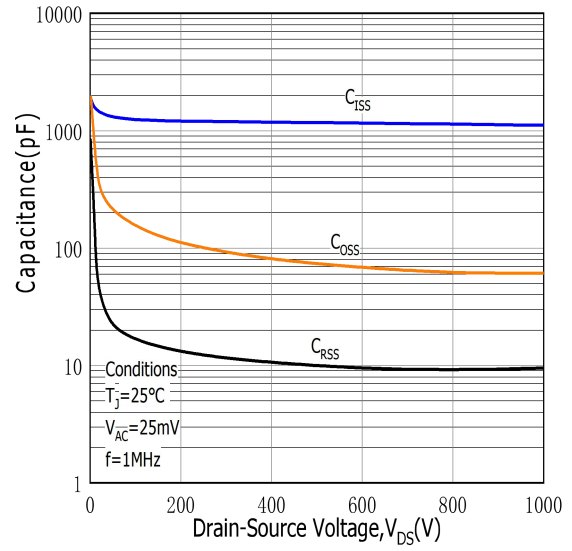
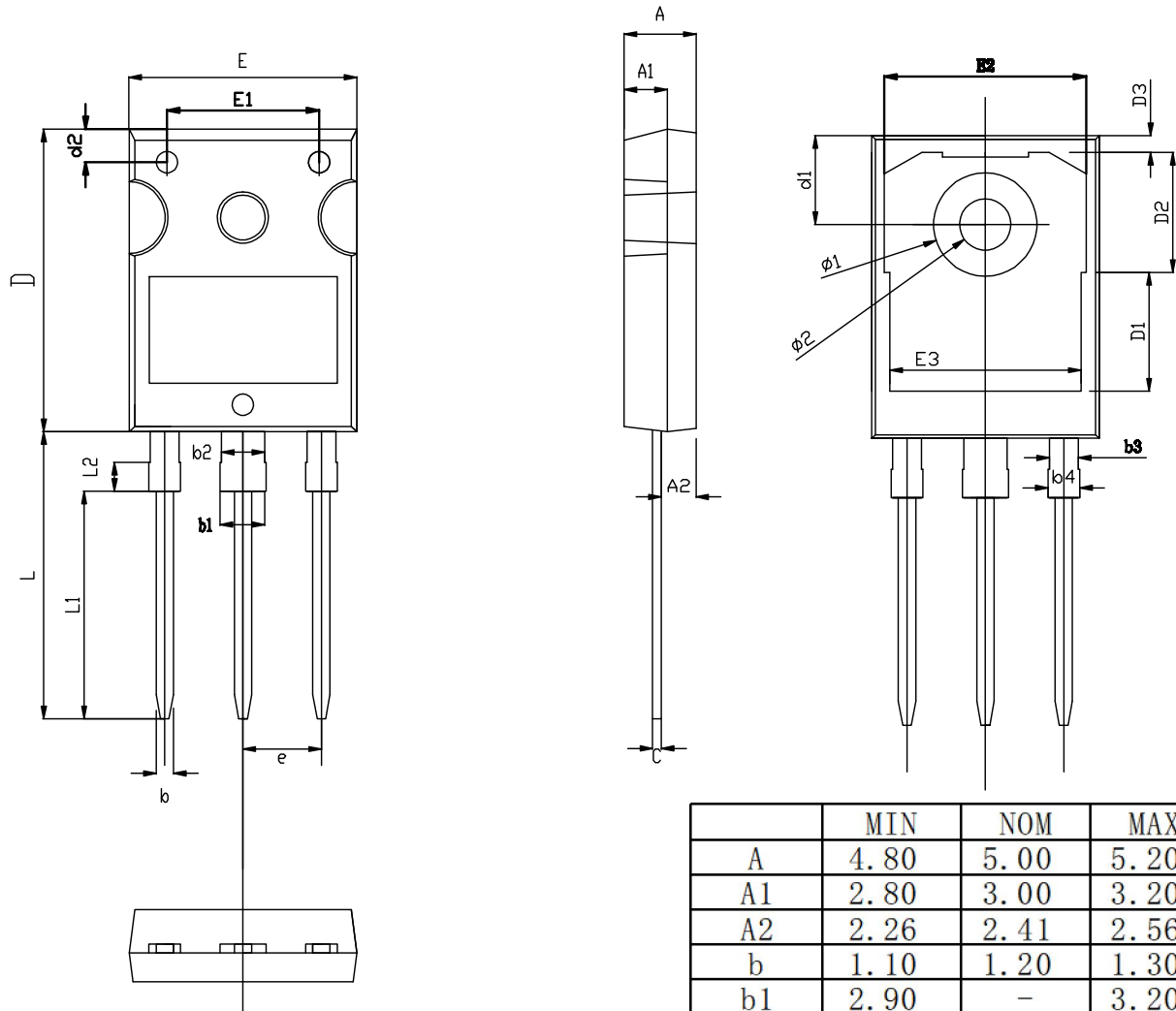

Figure.14 Capacitances vs. Drain-Source Voltage(0-1000V)



TO-247-3L PACKAGE OUTLINE



RECOMMENDED LAND PATTERN

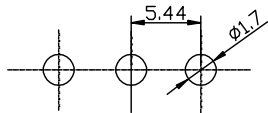

UNIT: mm

	MIN	NOM	MAX
A	4.80	5.00	5.20
A1	2.80	3.00	3.20
A2	2.26	2.41	2.56
b	1.10	1.20	1.30
b1	2.90	-	3.20
b2	2.90	3.00	3.10
b3	1.90	2.00	2.10
b4	2.00	-	2.20
c	0.50	0.60	0.70
D	20.80	21.00	21.20
D1		8.23	
D2		8.32	
D3		1.17	
d1	6.00	6.15	6.30
d2	2.20	2.30	2.40
E	15.60	15.80	16.00
E1		10.50	
E2		14.02	
E3		13.50	
e	5.34	5.44	5.54
L	19.72	19.92	20.12
L1		15.79	
L2		1.98	
$\phi 1$	7.10	7.19	7.30
$\phi 2$	3.50	3.60	3.70